





CLINICAL PRO SERIES EXAM TABLE INSTALLATION INSTRUCTIONS

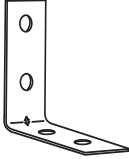
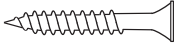

WARNING! EXAM TABLE CABINET CONTAINS POWERFUL LIFTING COMPONENTS. FAILURE TO USE AND FOLLOW THESE INSTRUCTIONS DURING THE INSTALLATION PROCESS COULD RESULT IN SEVERE PERSONAL INJURY TO USER OR DAMAGE TO PRODUCT. PLEASE CONTACT CUSTOMER SERVICE AT 866-725-6401 FOR ANY QUESTIONS.

Warning: Before opening Exam Cabinet table the cabinet must be anchored to either the wall or the Wall Bed.

Hardware Supplied

	Qty
 "L" Bracket	2
 1 1/4" Wood Screw	8
 1 3/4" Wood Screw	4
 2" Wood Screw	4
 5/8" Pan head Screw	4

Tools Needed

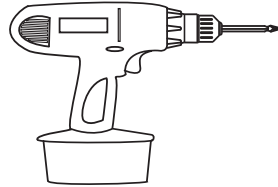

Cordless Screw Driver
Or Power Drill with Phillips bit

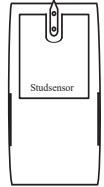

Stud Sensor



Tape Measure

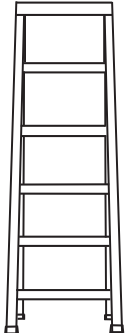

6' Step Ladder

HOW WILL YOU BE INSTALLING THE EXAM TABLE CABINET?

Look at options A, B and C below to determine the installation format and then follow only that option (letter) on the following pages.

3 OPTIONAL INSTALLATION FORMATS

Option
A
Exam Cabinet
Against Wall
Bed at Angle

Exam Cabinet installed next to the Wall Bed at an angle

NOTE: ILLUSTRATION SHOWN WITH EXAM CABINET INSTALLED TO THE RIGHT OF THE WALL BED. YOUR INSTALLATION MAY A MIRROR IMAGE (INSTALLED ON THE LEFT)



Continue Option A on the next page →

Option
B
Exam Cabinet
Against Wall
Bed (no angle)

Exam Cabinet installed flush (no angle) next to the Wallbed

NOTE: ILLUSTRATION SHOWN WITH EXAM CABINET INSTALLED TO THE RIGHT OF THE WALL BED. YOUR INSTALLATION MAY A MIRROR IMAGE (INSTALLED ON THE LEFT)



Continue Option B on the next page →

Option
C
Exam Cabinet
Free Standing
Against Wall.

Exam Cabinet installed freestanding against a wall. (Not against a Wall Bed).

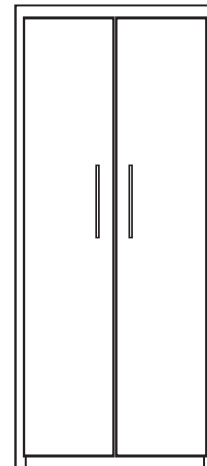

Continue Option C on the next page →



1 1/4" Wood Screw

Option
A
Continued
Exam Cabinet
Against Wall
Bed at Angle

Using four 1.25" wood screws for each support, attach the exam cabinet supports to the Wall Bed's Side Board as illustrated. Note that there are small pre drilled holes in the side board for proper positioning of the Angle Supports.

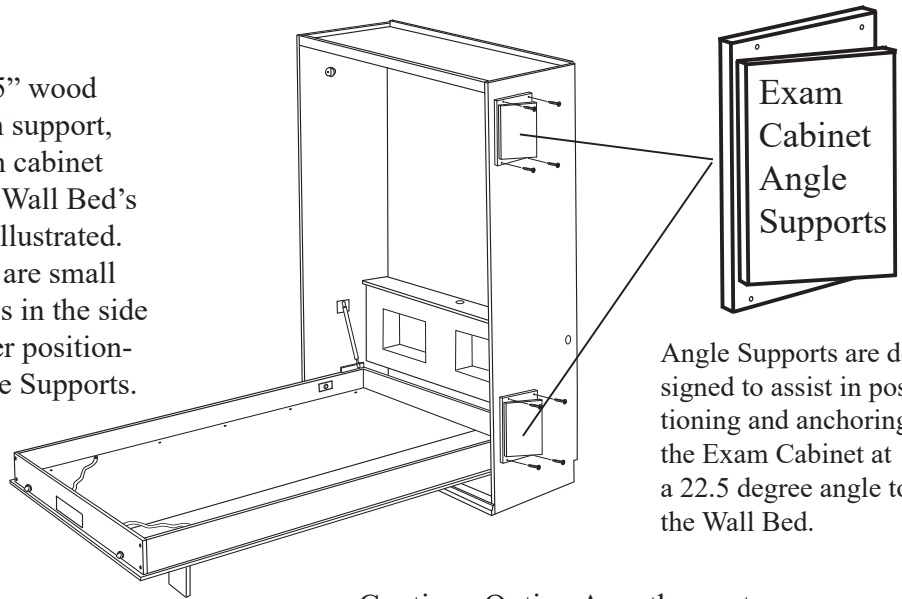

Continue Option A on the next page →



1 1/4" Wood Screw

Option
B
Continued
Exam Cabinet
Against Wall
Bed (no angle)

Using four 1.25" wood screws, anchor the cabinet to the side of the wall bed using the pre-drilled holes in the inside side of the cabinet.

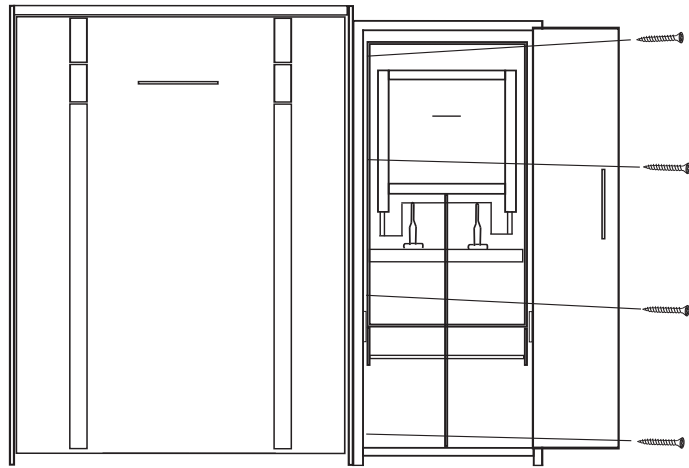

END OF OPTION B

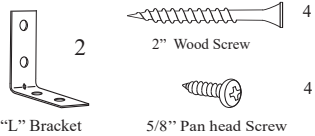

"L" Bracket

5/8" Pan head Screw

Option
C
Continued
Exam Cabinet
Free Standing
Against Wall.

Using a Stud Finder locate and mark the studs in your wall behind the Exam Cabinet. Attach "L" brackets to the top, back of the Cabinet using 3/4" Pan Head screws corresponding to the location of the studs in your wall. Now attach the "L" brackets to the studs in the wall using 2" wood screws (or screws appropriate for your type wall supports).

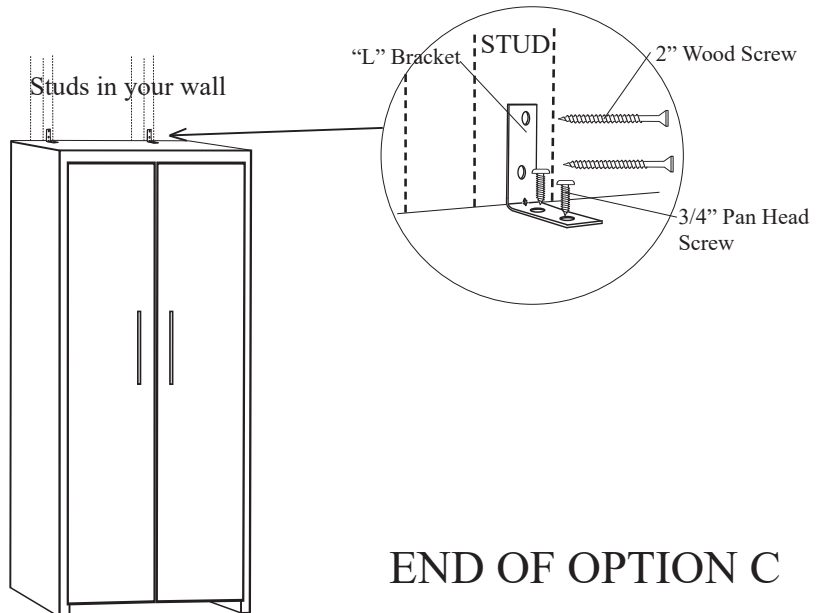

END OF OPTION C



4

1 3/4" Wood Screw

Option

A

Continued

Exam Cabinet
Against Wall
Bed at Angle

With the Exam Cabinet evenly in place against the Angle Supports and the front corner against the Wallbed use 1 3/4" wood screws through the holes provided right behind the face frame of the Exam Cabinet to fasten the front edge of the cabinet to the Wallbed.



Top View

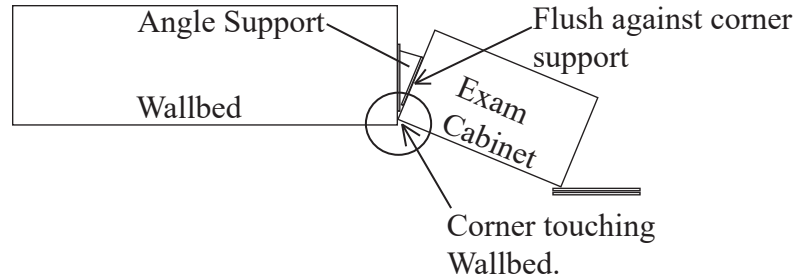

Continue Option A on the next page



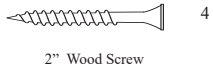

Option
A
Continued
Exam Cabinet
Against Wall
Bed at Angle

Carefully pull down the exam table and insert four 2" long wood screws through the holes provided in the side panel of the cabinet driving the screws into the Angle Supports attached to the Wall Bed's cabinet as illustrated below.

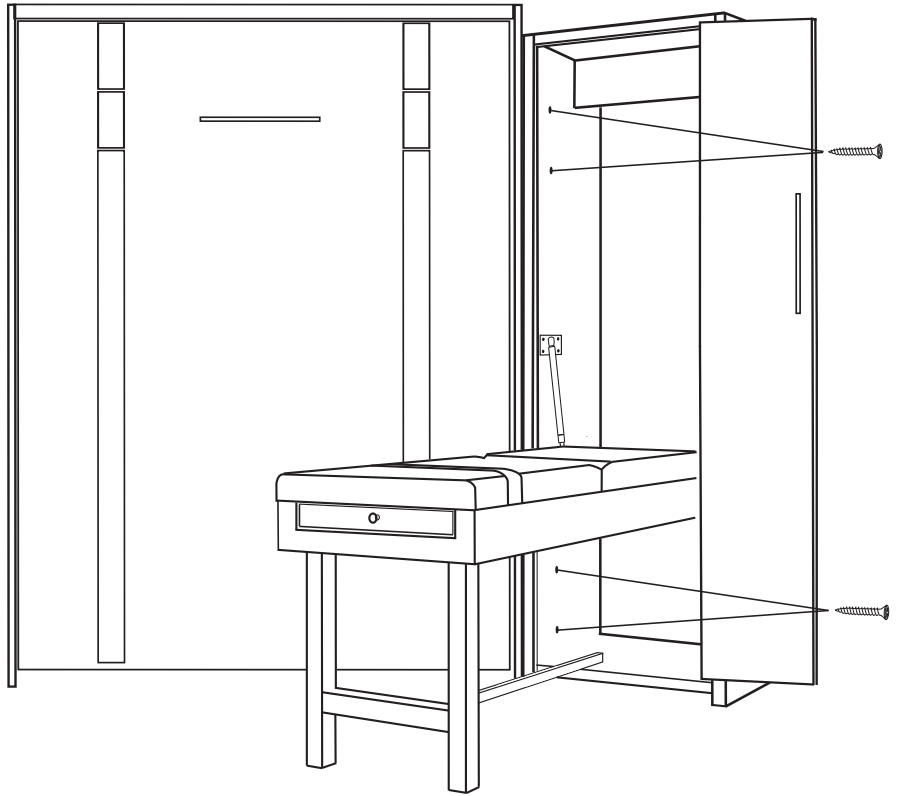

END OF OPTION A
