

# WILDING WALLBEDS SIDE MOUNT INSTALLATION INSTRUCTION

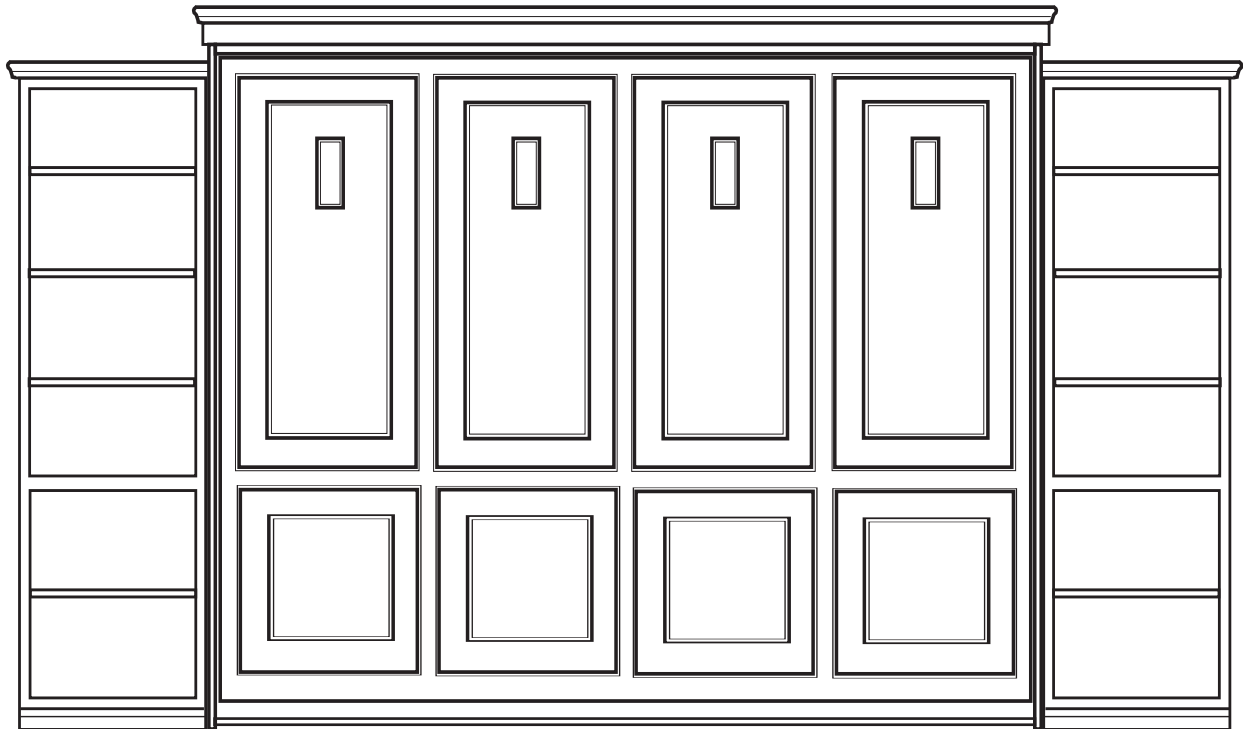



Bed with lights  
Booklet P-16-SH-SM



WARNING! ALL MURPHY/WALLBED SYSTEMS CONTAIN POWERFUL LIFTING COMPONENTS . FAILURE TO USE AND FOLLOW THESE INSTRUCTIONS DURING THE INSTALLATION PROCESS COULD RESULT IN SEVERE PERSONAL INJURY TO USER OR DAMAGE TO PRODUCT. PLEASE CONTACT CUSTOMER SERVICE AT 866-725-6401 FOR ANY QUESTIONS.

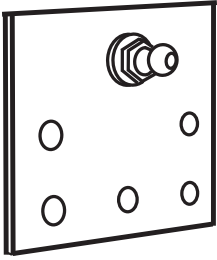

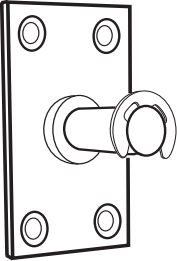
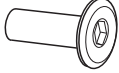
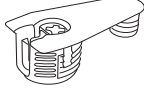
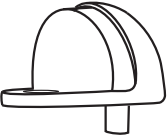
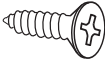
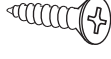
# Hardware Supplied

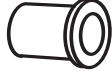
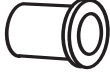
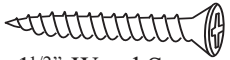
	QTY		QTY		QTY
	2		6		21
Upper Anchor plate		3/16" Machine Screw		Connecting Bolt	
	2		6		4
Pivot Point		3/16" Barrel Nut		Cam Fitting (extras)	
	2		6		8
Bed Stop		#12 x 3/4" Zinc Screw		#8 x 3/4" Black Screw	
			1		1
		1" Wood Screw		Black Barrel Catch	
			3		6
		3 1/2" Wood Screw		1 1/2" Wood Screw	

# Tools Needed

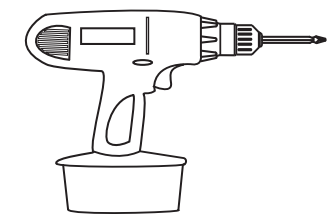

Cordless Screw Driver  
or Power Drill with Phillips bit



1/4" wood drill bit (provided)



Square Tip Bit  
(Provided)



Pliers



Tape Measure

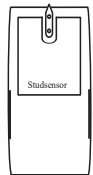

Stud Sensor



Small Regular Screw Driver

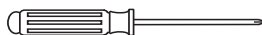

Phillips Screw Driver

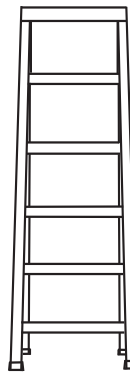

6' Step Ladder

# Wallbed Components

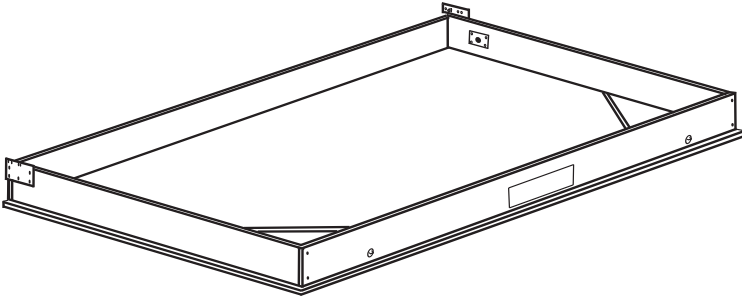

**Mattress Box**

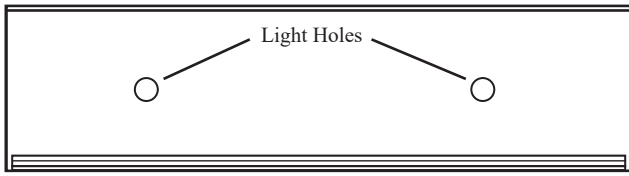

**Bridge Board**

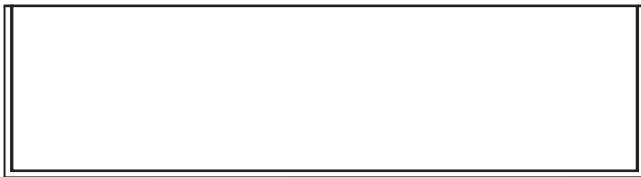

**Cap**

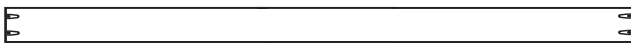

**Stretcher Board**

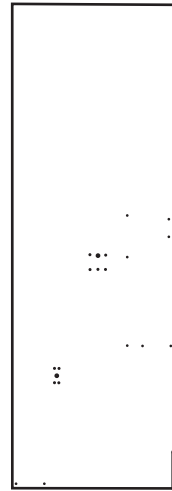

**Left Side Board**

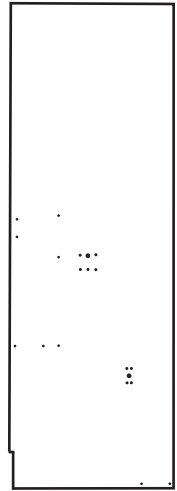

**Right Side Board**



**Headboard Face**

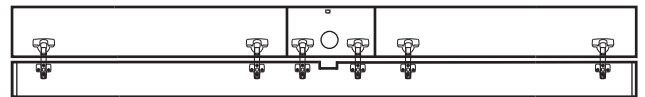

**Hinged Headboard Top**



**Headboard Bottom Shelf**

Hardware and parts needed for next step:

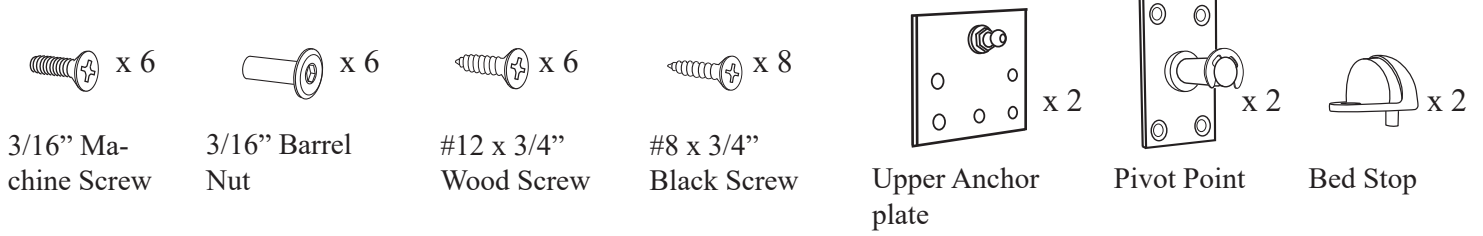

Step 1: Locate the left AND right Side Boards and install:

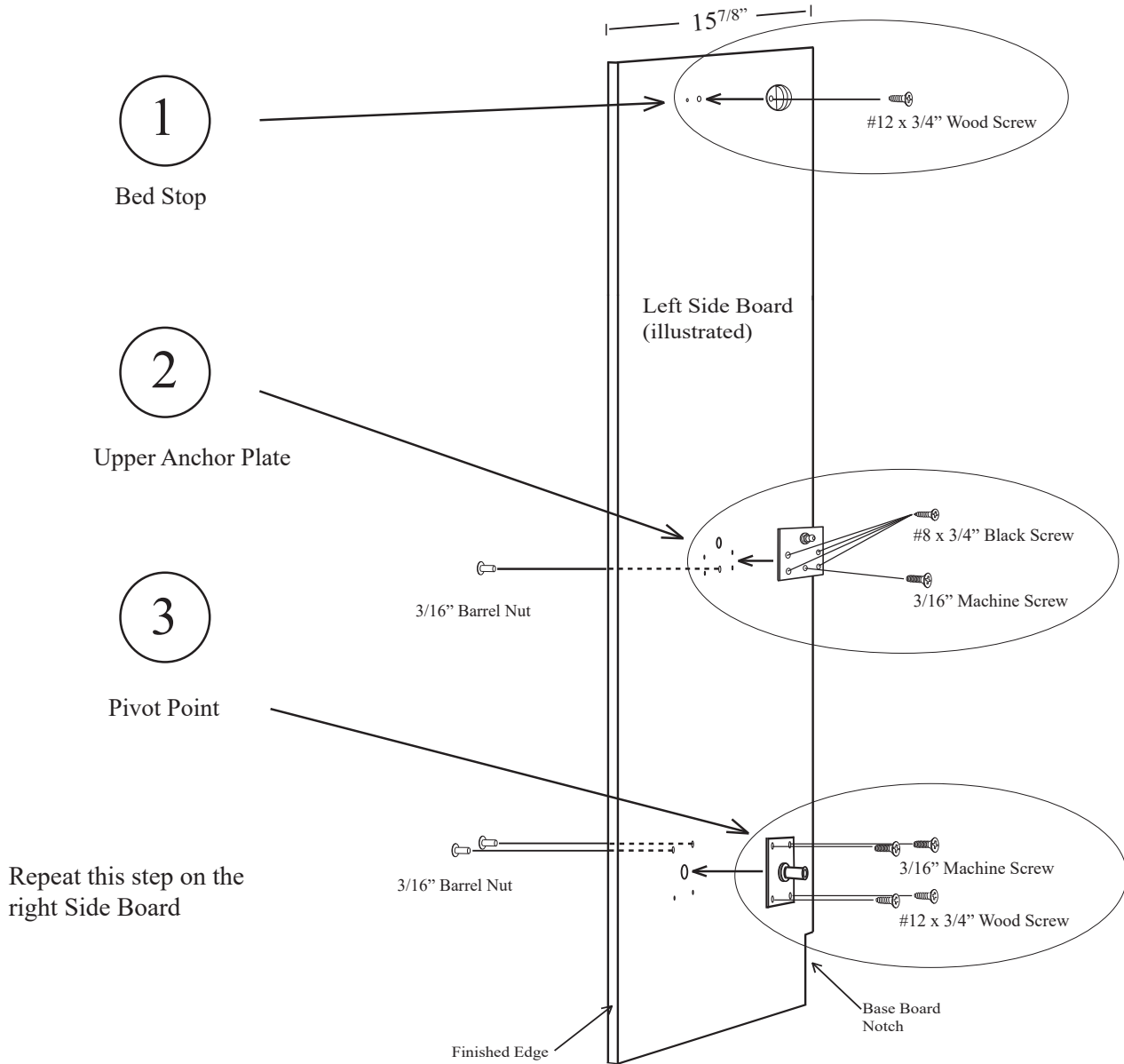

Hardware needed for next step:



Connecting Bolt

**Step 2:** Lay the right and left Side Boards down as illustrated and screw the Connecting Bolts into the holes provided as il-

Note: Screw the connecting bolts down until the collar of the connecting bolt is seated firmly against the surface of the wood.

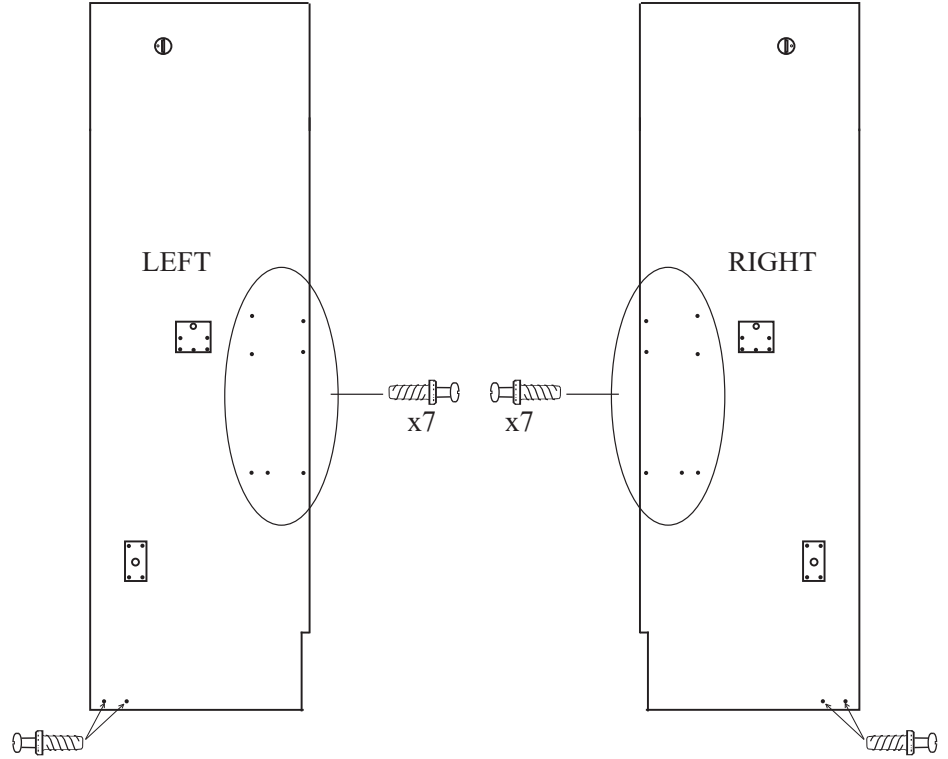
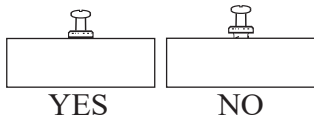

**Step 3:** Position the Mattress Box and the right and left Side Boards face down on the floor with the bottom of the Mattress Box approximately 2.5 feet from the wall where the bed will be installed.

**Step 4:** With a pair of pliers, remove the E-clips from the Pivot Posts on the Side Boards. Leave the white nylon spacers in place on the posts.

**Step 5:** Slide the Side Board pivot posts through the pivot holes in the Mattress Box as illustrated then replace the E-clips onto the pivot posts.

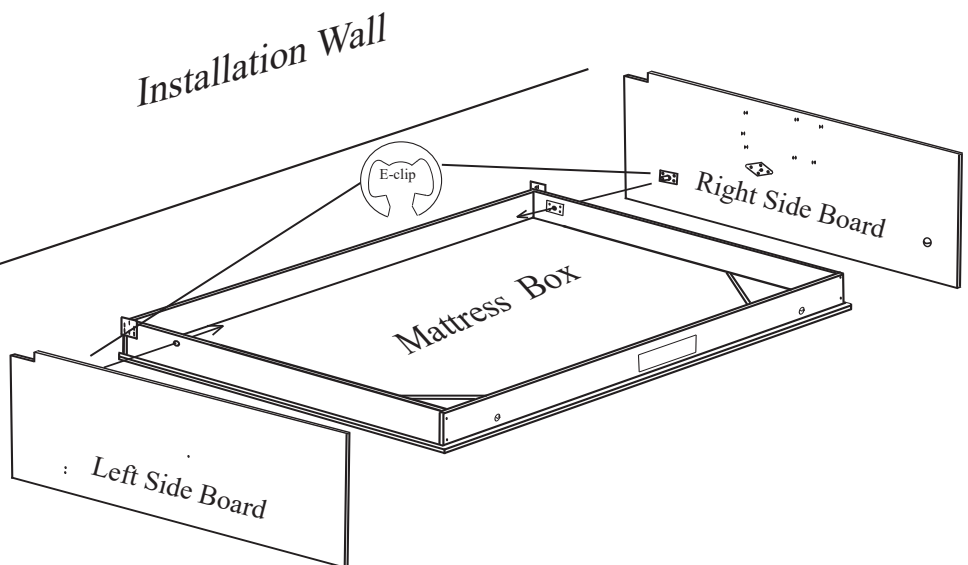

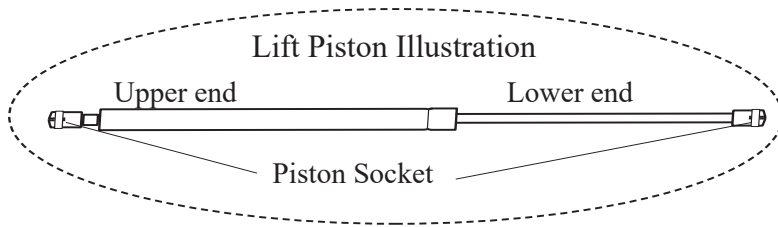

**Step 6:** Attach the lower end of the Lift Piston (skinnier end) onto the Lower Anchor Plate on the Mattress Box by positioning the socket of the piston directly over the ball stud on the anchor plate and pushing them on. The piston socket will snap into place over the ball. Repeat on the opposite side.

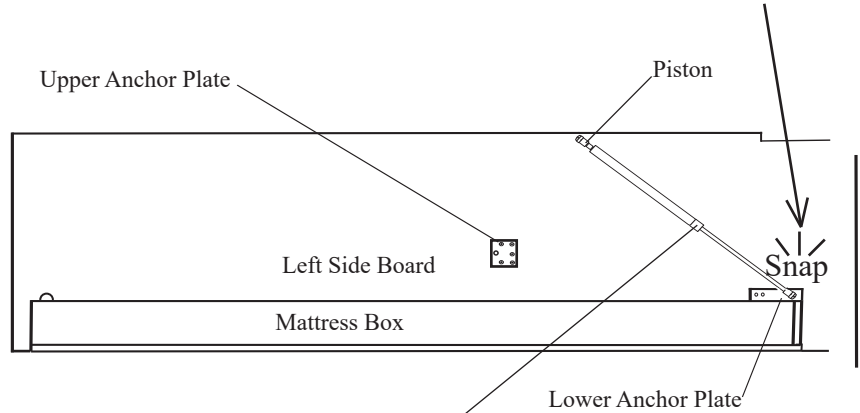

**Step 7:** Spread the Side Board tops so the Mattress Box has clearance to pass through the Bed Stops on the Side Boards. (Illustration 1)

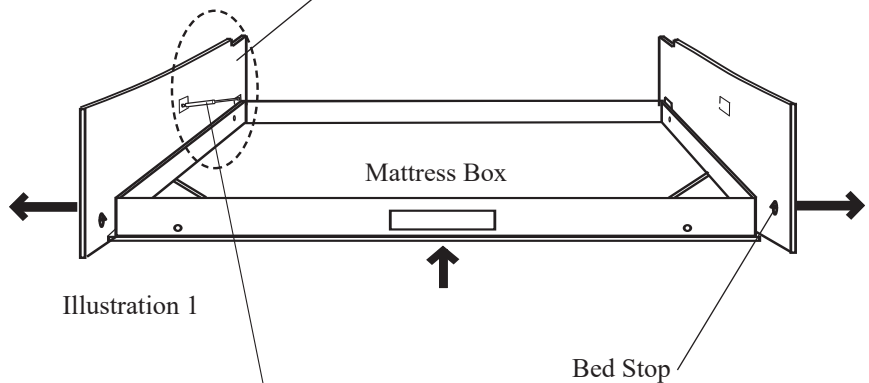

**Step 8:** This step will require two people. The first person will kneel down in front of the Mattress Box and lift it up about 4 to 5 inches while the second person positions the upper socket end of the Lift Piston directly over the ball stud on the upper anchor plate and snapping it into place. The first person will need to slightly raise and lower the Mattress Box to allow the Piston to line up and snap on. Repeat on the opposite side so both pistons are attached. (Illustration 2)

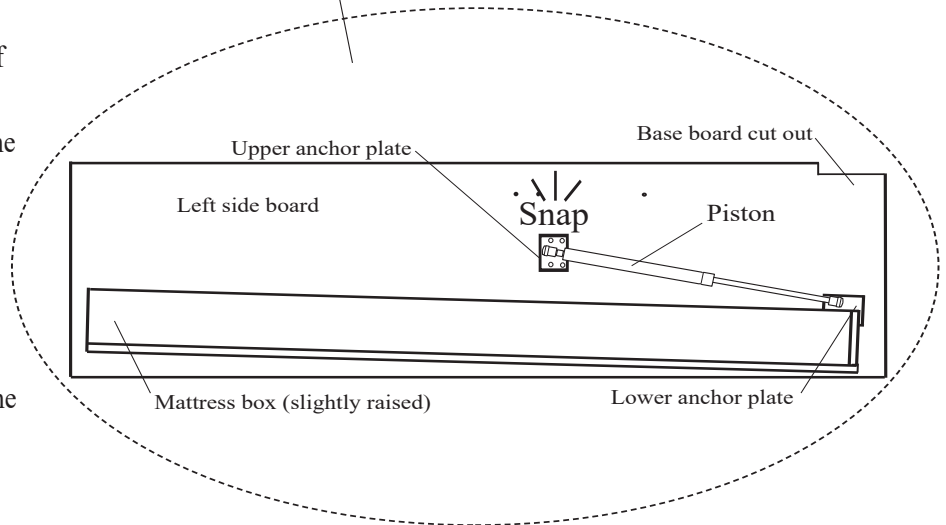
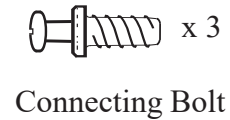
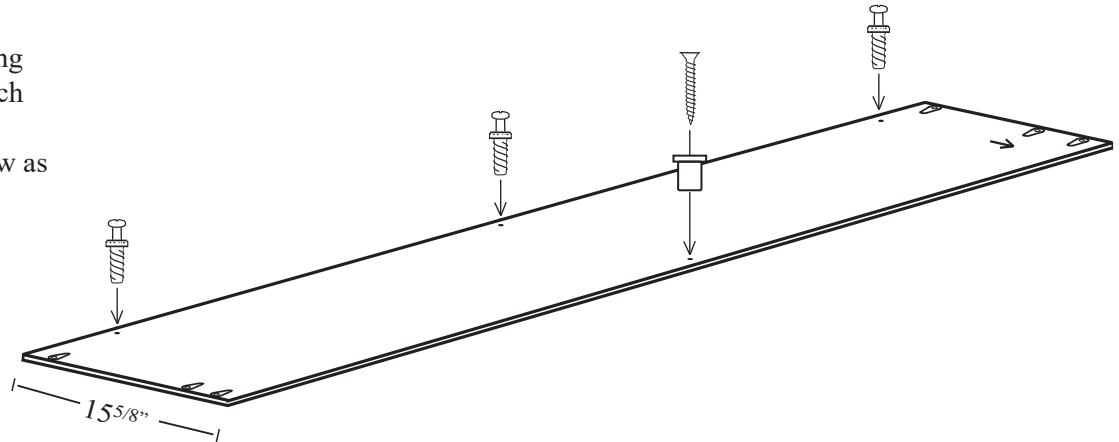

Illustration 2

Hardware needed for next step:



**Step 9:** Locate the Headboard and insert 3 Connecting Bolts into the three holes provided along bottom edge. Then attach the Black Barrel Catch using the 1" wood screw as illustrated.



**Step 10:** With the bed still laying face down on the floor the Headboard can be installed. **HAVE SOMEONE HELP WITH THIS STEP.** Slide the Headboard between the Side Boards and under the Connecting Bolts then slide the Cam Fittings into the Connecting Bolts and tighten the Cam fittings by turning them clockwise. Do this procedure by hand **DO NOT USE A POWER SCREW DRIVER.**

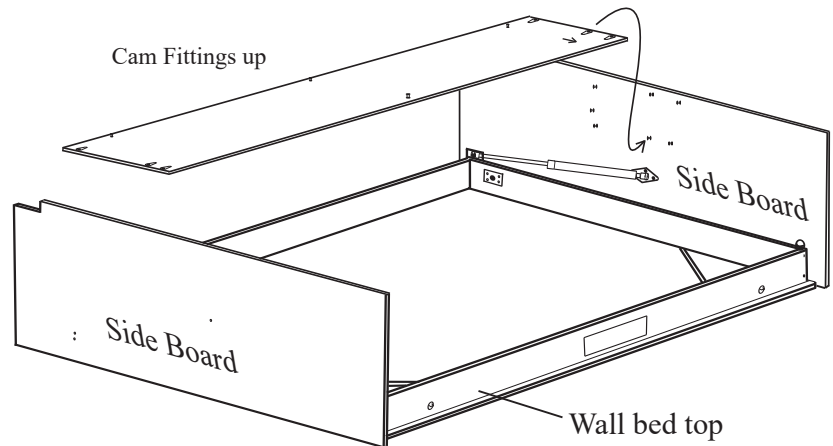



Step 11: Install the Storage Headboard bottom as illustrated. Make sure to orient the piece as shown with the Cam Fittings down.

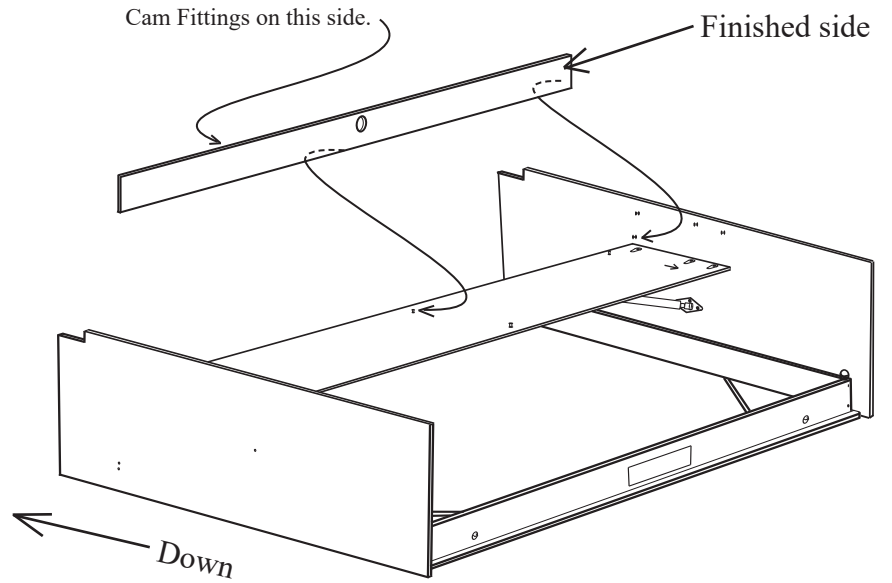

---

Step 12: Install the hinged storage door unit as illustrated.

Helpful hint: lift the center section to get the unit positioned correctly

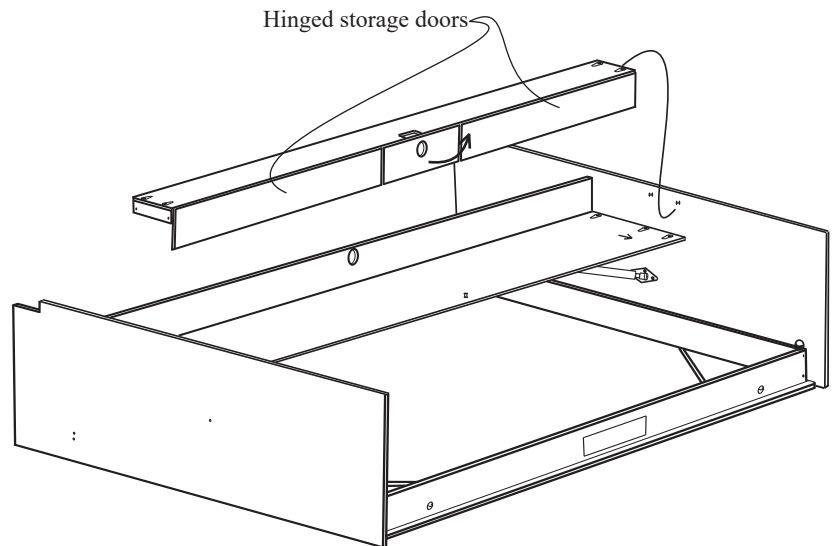

Step 13: Once the Head Board is attached to the Side Boards place the Bed Bumpers onto the Bed Rail on both sides of the bed box as illustrated.

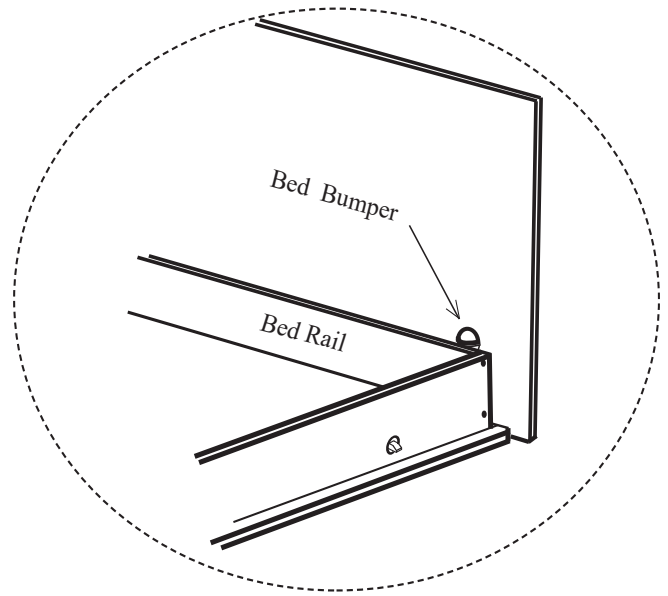

Step 14: Locate the Stretcher Board and slide it between the Side Boards at the bottom of the Wallbed. Insert the Connecting Bolts into the Cam fittings and tighten them by turning the cam clockwise. Do this procedure by hand DO NOT USE A POWER SCREW DRIVER.

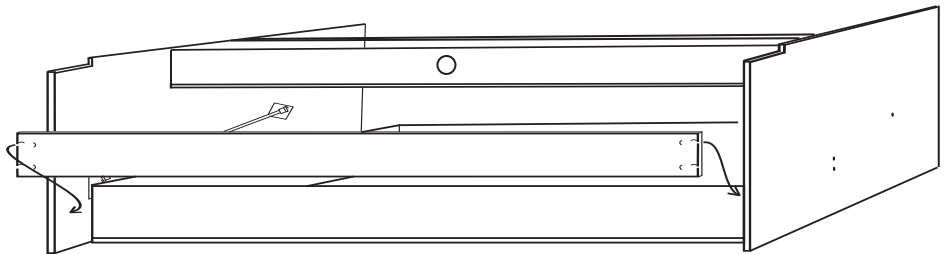

Step 15: Have someone help lift the Wall Bed into the standing position. Leave it about 2 feet from the wall the bed is to be installed against so there will be room to work behind the bed.

**WARNING:** The bed front is heavier and the Wall Bed unit may not stand on its own.

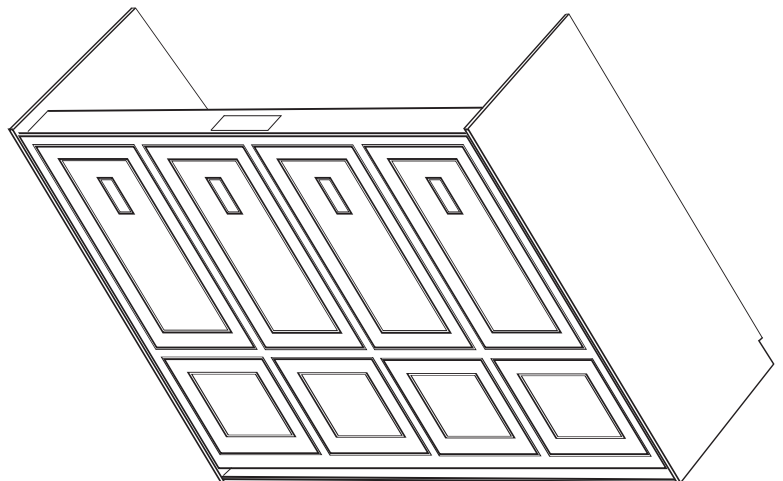

**HEAVY TWO PEOPLE REQUIRED!**

**Step 16:** Place the Bridge Board on top of the Wall Bed and position it so the front of the Bridge is flush with the front of the Side Boards.

Helpful Hint: The Bridge Board will have two holes for can lights.

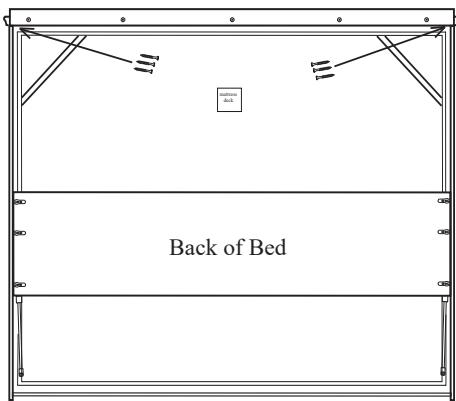
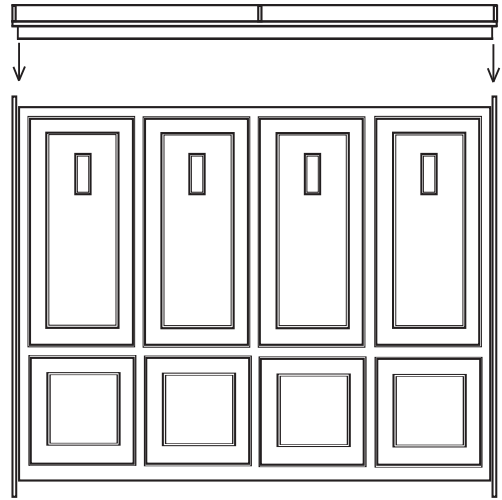

Hardware needed for next step



**Step 17:** From the back of the Wall Bed attach the Bridge to the Side Boards using three (on each side) 1 1/2" screws. Place the screws through the holes provided in the corner blocks on the Bridge Board and drive them into the Side Boards.



IF YOU PURCHASED LIGHTS FOR YOU WALLBED YOU MUST REFER TO THE LIGHT KIT INSTRUCTIONS AND INSTALL THE LIGHT KIT BEFORE MOVING ON.  
(Light Kit instructions are in the Light Kit box)

**Step 18:** Once the bed is standing up, slide it back and position it against the wall where it is to be installed. Check the gap between the Side Boards and the Bed Frnt panel on both sides. The gap at this point will probably need to be adjusted. You can adjust the gap by pushing the bed to one side or the other at the top of the bed. Pushing it will even the gap from top to bottom on each side. At this point don't worry if one side has a larger gap than the other as long as each sides gap is about the same from top to bottom on each side.

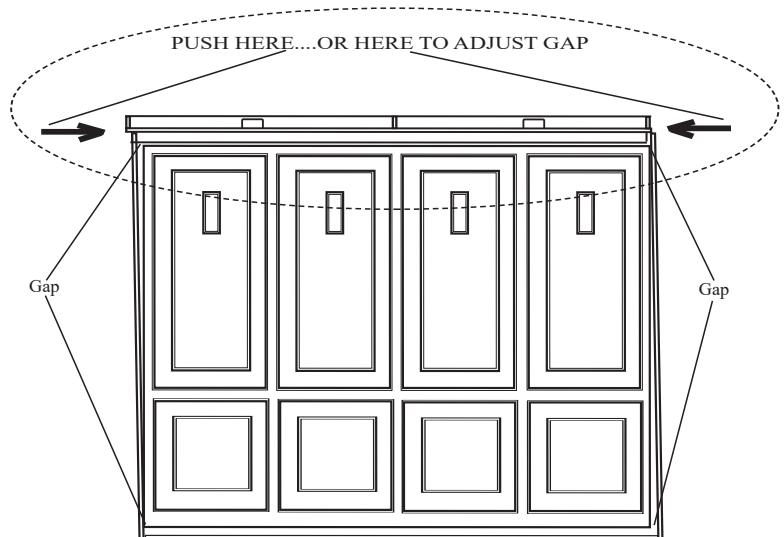

**WARNING! THE NEXT STEP MAY REQUIRE PROFESSIONAL HELP.**

IF YOUR WALLS ARE NOT TRADITIONAL WOOD FRAMING, YOU MAY NEED TO HIRE A HANDY-MAN OR CONTRACTOR TO HELP IN ANCHORING THE BED UNIT TO YOUR WALL. FAILURE TO PROPERLY ANCHOR THE BED CABINET COULD CAUSE SEVERE PERSONAL INJURY OR DEATH. CALL TECHNICAL SUPPORT AT 866-725-6401 IF YOU HAVE ANY QUESTIONS.

---

Hardware needed for next step



1/4" wood drill bit (provided)



3 1/2" Wood Screw

3

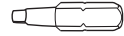

Square Tip Bit  
(Provided)

---

**Step 19:** Using a stud finder locate the studs in your wall. Then mark their location lightly with a pencil just above the Anchor Board located at the back of the Bridge Board. **IMPORTANT:** Locate at least 3 studs that will be used in anchoring your bed to the wall.

**Step 20:** Using the 1/4" drill bit provided, pre-drill holes through the Anchor Board corresponding with the 3 studs you will use to anchor your bed to the wall. Now using three, 3 1/2" screws anchor the Wall Bed to the wall. **IT IS EXTREMELY IMPORTANT THAT THE BED IS ANCHORED SECURELY TO THE WALL.**

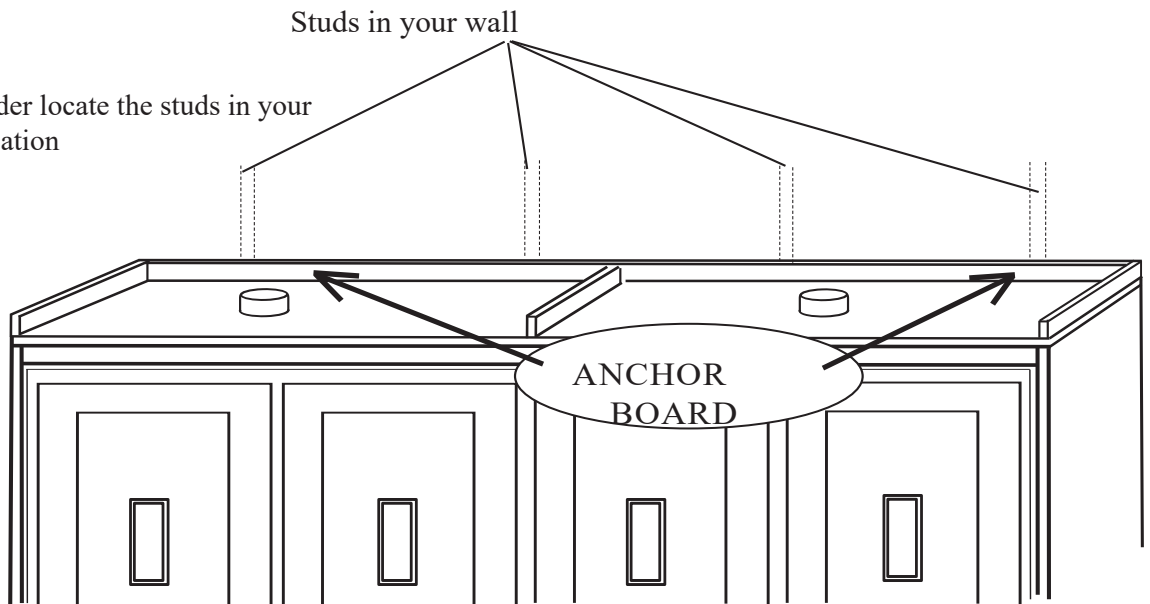

Step 21: Check the gap alignment again. If it looks correct skip this step. If the gap is not correct, meaning that the Bed Front is too close to the Side Board or even touching it at the top on one side. It can be adjusted after the Bed unit is attached to the wall but it will require two people. The procedure will require the bottom of the bed to be moved slightly to the left or right depending on which top corner is too close. If the bed is too close on the top right side for instance the right side (bottom) will need to be slid to the left slightly. Have one person push the bed at the bottom while the second person pulls on the opposite bottom side.

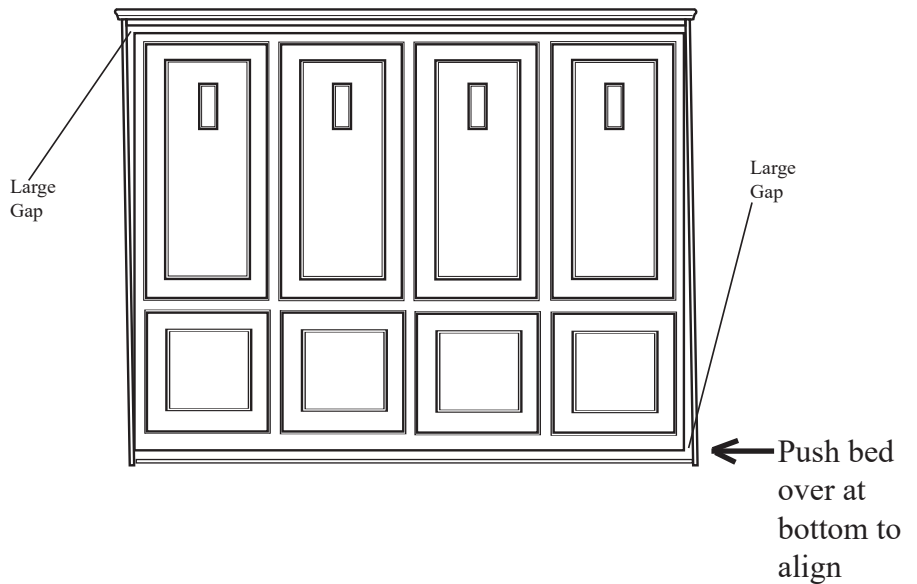

---

Step:22 Place Bridge Cap on the bridge board.

Note:Cap is not designed to be anchored to the bed.

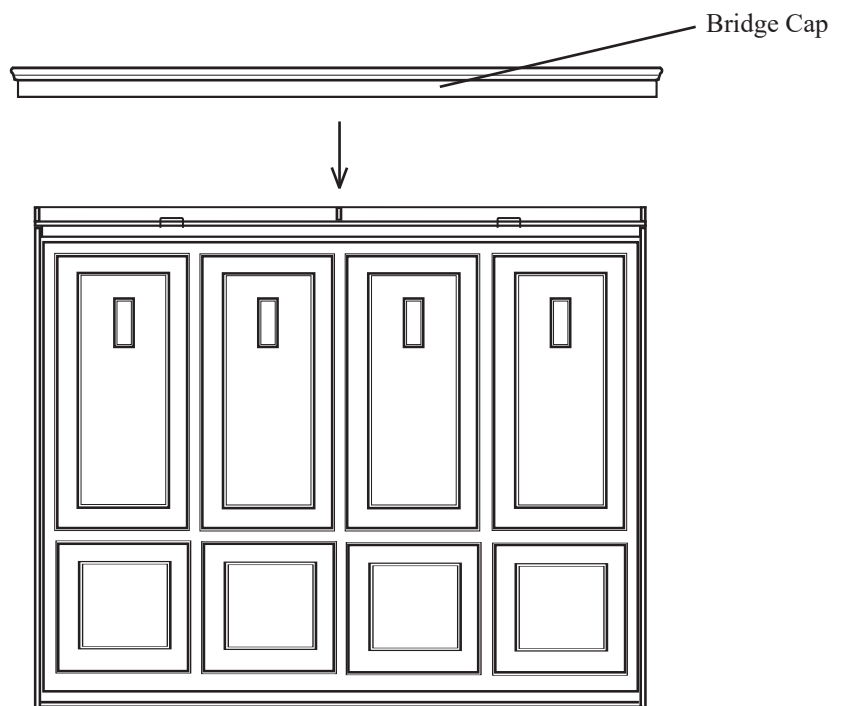

## OPTIONAL SIDE CABINETS

Hardware needed for next step



1 1/4" Wood Screw  
(located inside cabinet)

NOTE: It is recommended to attach the side cabinets to the bed so they fit tight to the bed and are secured properly.

Step 23: Anchor the Side Cabinet to the Bed by first pre-drilling two 1/4" holes at the inside edge of the side cabinet. Position the holes close to the front edge of the side cabinet just behind the Face Frame. One hole should be near the top, the second about 15" from the bottom of the cabinet.

Step 24: Use three 1 1/4" wood screws through pre-drilled holes, attach Side Cabinets to the bed.

